

- Typritning
- Förhandskopia
- Granskningshandling
- Arbetshandling
- Relationshandling

| | | | | | | | |
|---|-------------------|--------------------------|-----------------------------|---|----------|-----------|------------|
| B | A | Pos | Benämning | Material | Mod. nr | Dim. | |
| Ant. | Qty. | Item | Name of Item | | Mod. No. | | Anm. Note. |
|  | | | RJ-Förbundet www.rj85.nu | RJ85 RIGG OCH SKROV FORM OCH LAYOUT | | | |
| Rit. Dröm. | Konstr. | Design. | Granskt. | Checked. | Godk. | Approved. | |
| TS | RJ | | | | | | |
| Datum. Date. | Order nr. Job No. | Tot. vikt. Total weight. | Skala. Scale. | Ritning nr. Drawing No. | Rev. | | |
| 041018 | | | | 10001 | | | |

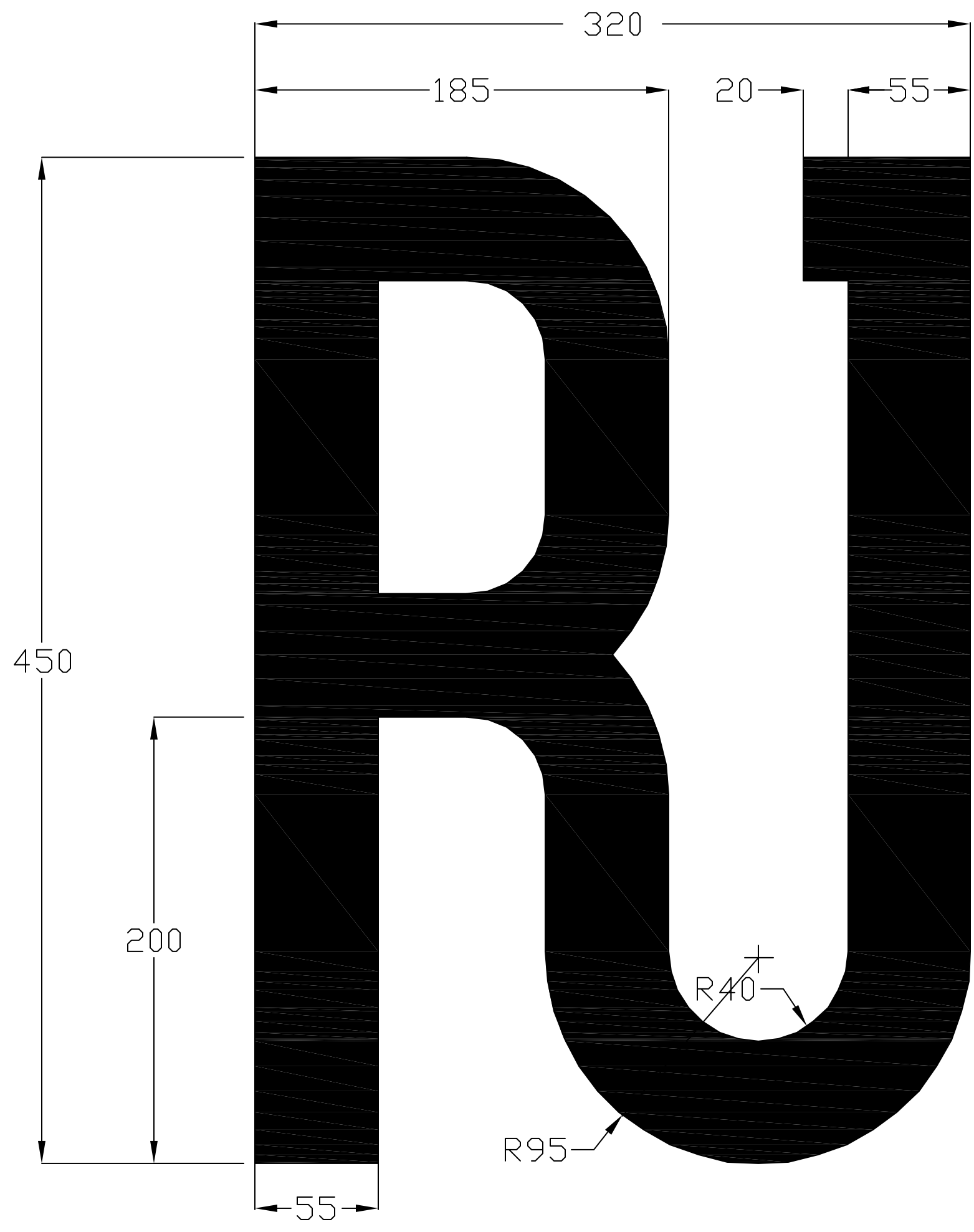

- Förhandskopia
- Granskningshandling
- Arbetshandling
- Relationshandling

| B | A | Pos | Beskrivning | Material | Med. nr | Övn. | Änrs. Notis |
|------------------------|-----|---------|---------------------------------------|-----------|----------|--------------|---|
| Anb. | Qty | Item | Name of Item | | Med. No. | | |
| | | | RJ RJ-Förbundet www.rj85.nu | | | | RJ85 KLASSMÄRKE FULLSKALA FÖR SEGEL |
| | | | TS RJ | | | | |
| Order no. | | Job No. | | Tot. vikt | | Total weight | |
| 040603 | | | | | | | |
| Erling nr. Drawing No. | | | | | | Rev. | |
| 10002 | | | | | | | |

| Rev | Ant | Ändring | Datum | Inf. | Godk. |
|-----|-----|------------|----------|------|-------|
| 1 | | Typritning | 04.10.18 | TS | |

Alla vant och staglängder är inklusive vantskruv och toggles.

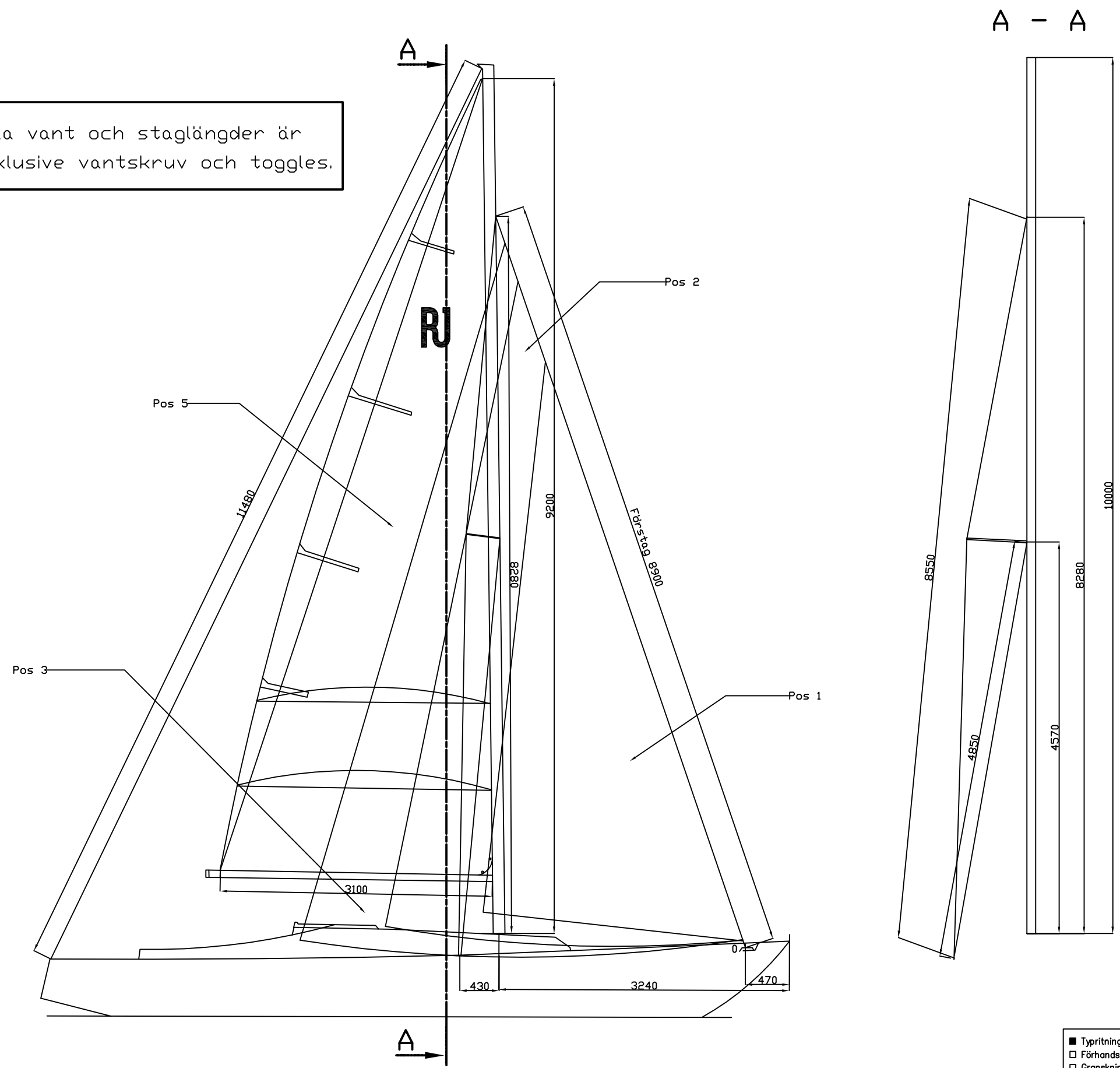

| Ant. | Qty. | Item | Benämning | Material | Mod. nr | Dim. | Anm. Note. |
|------|------|------|--------------------|---------------|---------|-----------|------------|
| 6 | | 7 | Vant och stag | Syrafäst wire | 316L | min. 5 mm | |
| 1 | | 6 | Mast, bommar, rigg | 10007 | | | |
| 1 | | 5 | Sprinkler | 10006 | | | |
| 1 | | 4 | Storsegel | 10005 | | | |
| 1 | | 3 | Genua I | 10004-3 | | | |
| 1 | | 2 | Genua II | 10004-2 | | | |
| 1 | | 1 | Kryeslock | 10004-1 | | | |

- Typritning
- Förhandskopia
- Granskningshandling
- Arbetshandling
- Relationshandling

RJ RJ-Förbundet
www.rj85.nu

RJ85
SEGEL OCH RIGGRITNING
SAMMANSTÄLLNING

| Rit. Dröm. | Konstr. Design. | Gransk. Checked. | Godk. Approved. | Datum. Date. | Order nr. Job No. | Tot. vikt. Total weight. | Skala. Scale. | Ritning nr. Drawing No. | Rev. |
|------------|-----------------|------------------|-----------------|--------------|-------------------|--------------------------|---------------|-------------------------|------|
| TS | RJ | | | 040620 | | | | 10003 | |

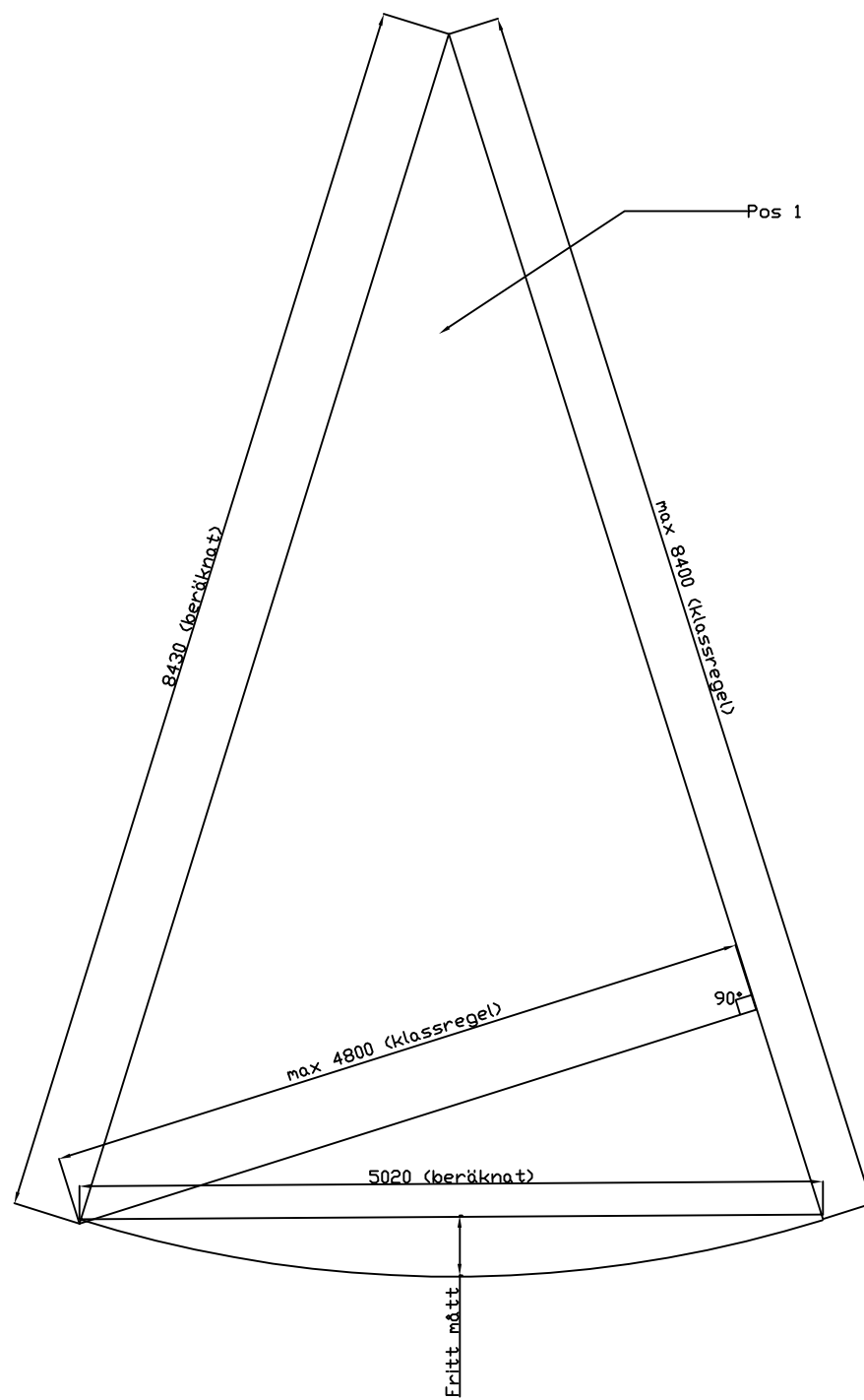

10004-1
Genua I: 20.0 kvm
(Klassregel)

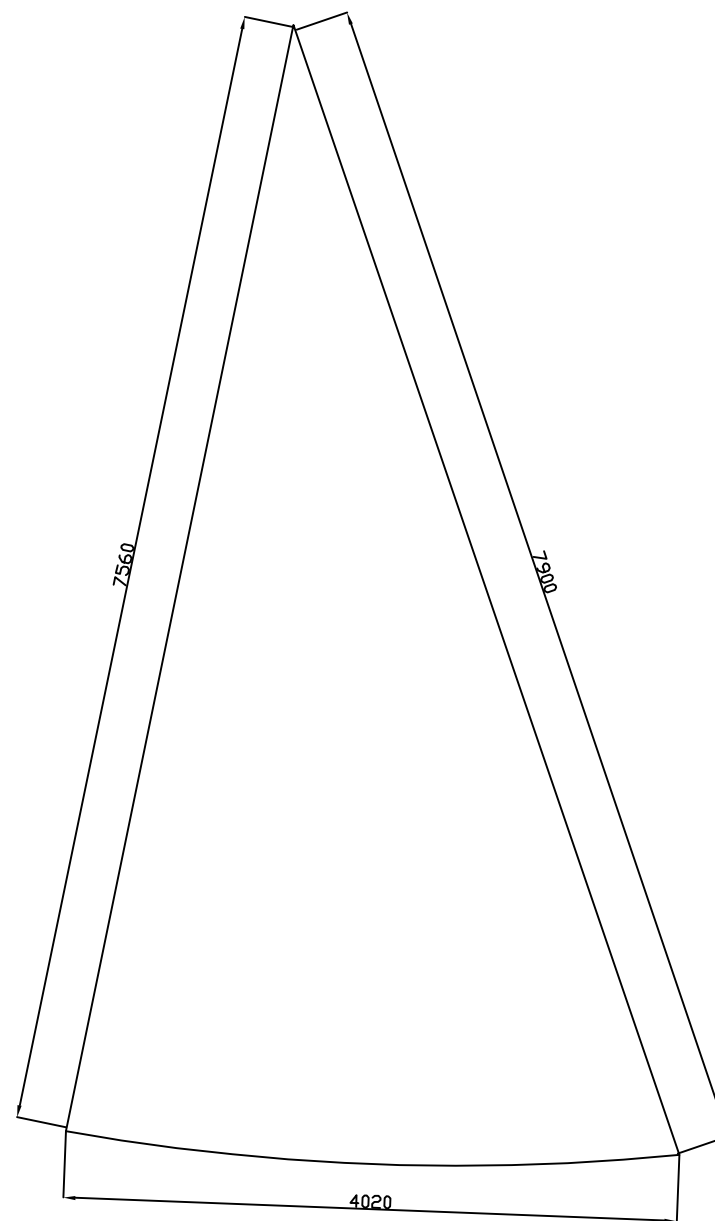

10004-2
Genua II: 15.0 kvm

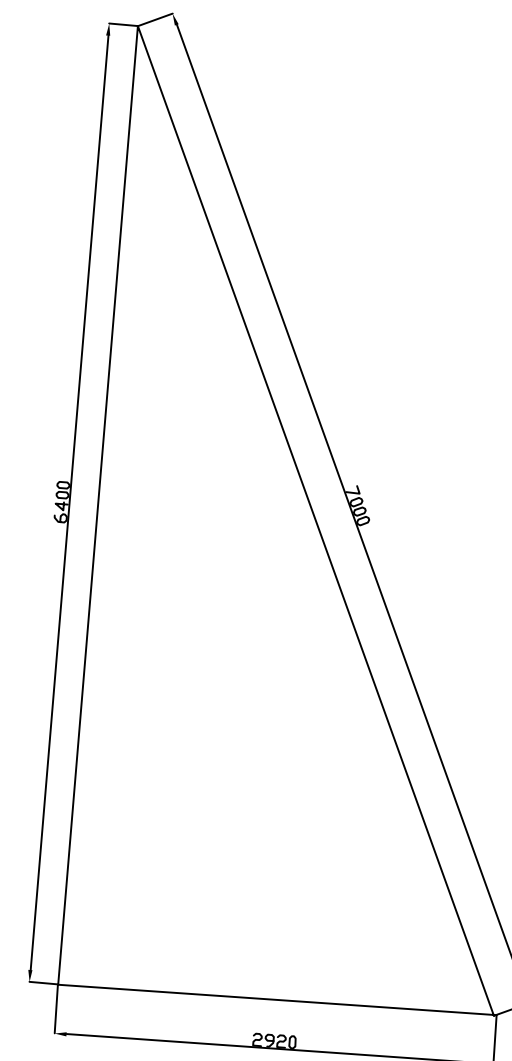

10004-3
Kryssflock: 9.3 kvm

- Typritning
- Förhandskopia
- Granskningshandling
- Arbetshandling
- Relationshandling

| 1 | | 3 | Kryssflock | 10004-3 | | | |
|---|---------|-----------|------------------------------|--------------------------------|---------------|-------------------------|------------|
| 1 | | 2 | Genua II | 10004-2 | | | |
| 1 | | 1 | Genua I, dukvikt min 175g/m2 | 10004-1 | | | |
| B | A | Pos | Benämning | Material | Mod. nr | Dim. | Anm. Note. |
| Ant. | Qty. | Item | Name of Item | | Mod. No. | | |
|  RJ-Förbundet www.rj85.nu | | | | RJ85 FÖRSEGL MÄTTRITNING | | | |
| Rit. Dröm. | Konstr. | Design. | Gransk. | Checked. | Godk. | Approved. | |
| TS | RJ | | | | | | |
| Datum. | Date. | Order nr. | Job No. | Tot. vikt. | Total weight. | Skala. | Scale. |
| 040620 | | | | | | | |
| | | | | | | Ritning nr. Drawing No. | 10004 |
| | | | | | | Rev. | |

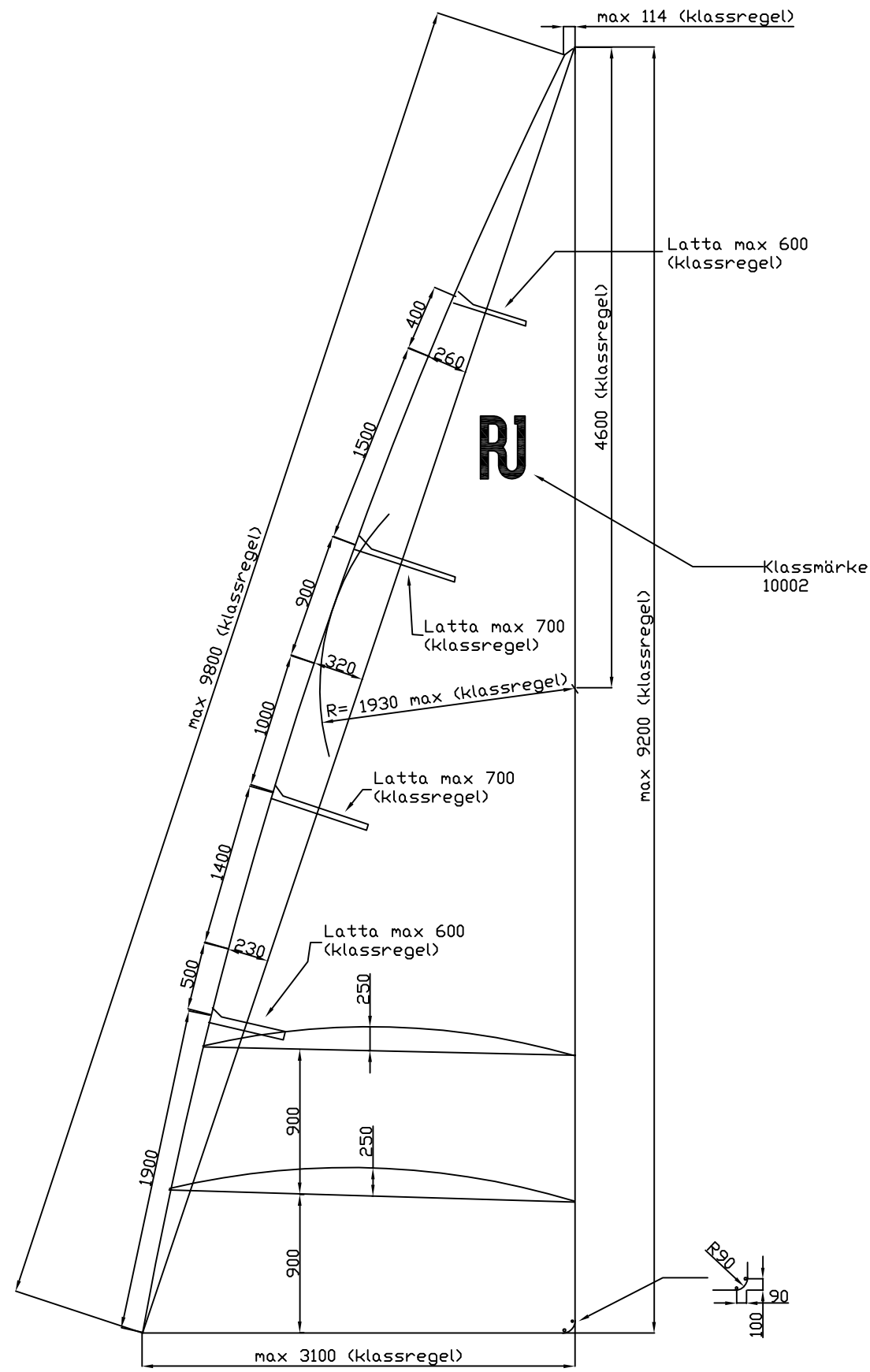

- Typritning
- Förhandskopia
- Granskningshandling
- Arbetshandling
- Relationshandling

| | | | | | | | |
|------------|---------|-----------|--------------|------------|---------------|----------------------------------|-------------|
| 1 | | 1 | | Klassmärke | 10002 | Svart | |
| B | A | Pos | Benämning | | Material | Mod. nr | |
| Ant. | Qty. | Item | Name of Item | | | Mod. No. | Dim. |
| | | | | RJ | | RJ85 STORSEGEL MÄTTRITNING | |
| Rit. Drem. | Konstr. | Design. | Granskt. | Checked. | Godk. | Approved. | |
| TS | RJ | | | | | | |
| Datum. | Date. | Order nr. | Job No. | Tot. vikt. | Total weight. | Skala. | Scale. |
| 040620 | | | | | | | |
| | | | | | | Ritning nr. | Drawing No. |
| | | | | | | 10003 | |
| | | | | | | Rev. | |